

short description

SE-Power FS Safety Module FSM 2.0 MOV

for the servo controllers of the SE-Power FS series

Translation

English



Afag Automation AG
Luzernstrasse 32
CH – 6144 Zell
Switzerland

phone: +41 (0)62 959 86 86
fax: +41 (0)62 959 86 87
e-mail: sales@afag.com
internet: www.afag.com

© 2015

→ The full documentation for the safety module and the documentation of the servo controllers SE-Power FS can be found in PDF format on our website at www.afag.com.

The present short description applies to the following versions:

- SE-Power FS Safety Module FSM 2.0 MOV, from revision 1.1
- Servo controller SE-Power FS, firmware from version 4.1.801.1.1 and hardware as follows depending on the device: SE-Power FS 1kVA from version 6.0, SE-Power FS 3kVA from version 4.1 and SE-Power FS 6kVA from version 4.1
- Parameterisation program Afag SE-Power ServoCommander from version 4.1.801.1.1 with SafetyTool from version 1.0.2.1

1 Safety

1.1 General safety notes

- ❖ Observe in addition implicit the „Safety notes for electrical drives and controllers“ for the servo controllers SE-Power FS. These can be found in the corresponding operating instructions.

→ Note

Loss of the safety function!

Non-compliance with environmental and supply conditions can lead to loss of the safety function.

- ❖ Keep the specified ambient and connection conditions, in particular the input voltage tolerances → section 11.

→ Note

Damage to the safety module or the servo controller by improper use.

Improper use can result in damage.

- ❖ Switch off supply voltages before mounting and installation work. Do not switch on supply voltages, where assembly and installation work has been completed.
- ❖ Never pull off or plug the module when the servo controller is energised!
- ❖ Observe the regulations for handling electrostatic sensitive devices.

1.2 Proper usage

The SE-Power FS Safety Module MOV serves as an extension of the servo controller SE-Power FS to achieve safety functions STO, SS1, SS2, SOS, SLS, SSR, SSM, SBC according to EN 61800-5-2.

The servo controller SE-Power FS with SE-Power FS Safety Module MOV is a product with safety features and designed for installation in machines or automated systems and uses the following:

- in perfect technical condition,
- in original condition without unauthorized changes,
- within the limits defined by the technical specifications of the product (→ section 11),
- in the industrial sector.

→ Note

Any damage resulting from unauthorized interference or improper use voids the warranty and liability claims against the manufacturer.

1.3 Foreseeable Misuse

For improper use include the following foreseeable misuse:

- the use in a device other than a SE-Power FS
- the outdoor use,
- the use in non-industrial areas (living area),
- use outside the limits of the product defined in the technical data,
- unauthorised modifications.

→ Note

- The STO function is insufficient as the sole safety function for drives subject to permanent torque (e.g. suspended loads).
- Bypassing of safety equipment is impermissible.
- Repairs on the module are impermissible!

The STO (Safe Torque Off) function does not provide protection against electric shock, only against hazardous movements!

1.4 Achievable safety level, safety function in accordance with EN ISO 13849 / EN 61800-5-2

The safety module fulfils the basic test requirements

- Category 4 / PL e in accordance with EN ISO 13849-1,
- SIL CL 3 in accordance with EN 62061,

and can be used in applications up to cat. 4 / PL e in accordance with EN ISO 13849-1 and up to SIL 3 in accordance with EN 62061 / IEC 61508.

The achievable safety level depends on the other components used to achieve a safety function.

2 Requirements for product use

- ❖ Make the complete documentation available to the design engineer, installer and personnel responsible for commissioning the machine or system in which this product is used.
- ❖ Take into consideration the legal regulations applicable for the destination, as well as:
 - regulations and standards,
 - regulations of the testing organizations and insurers,
 - national specifications.

2.1 Technical prerequisites

General conditions for the correct and safe use of the product, which must be observed at all times:

- ❖ Comply with the connection and environmental conditions of the safety module (→ section 11), the servo drive and all connected components. Only compliance with the limit values or load limits will enable operation of the product in compliance with the relevant safety regulations.
- ❖ Observe the instructions and warnings in this documentation.

2.2 Qualification of the specialist personnel (requirements for personnel)

The device may only be commissioned by a qualified electro technician who is familiar with:

- the installation and operation of electrical control systems,
- the applicable regulations for operating safety-engineered systems,
- the applicable regulations for accident protection and occupational safety, and
- the documentation for the product.

2.3 Diagnostic coverage (DC)

Diagnostic coverage depends on the integration of the servo drive with safety module into the control loop system, the motors/position encoders used, as well as the implemented diagnostic measures.

If a potentially dangerous malfunction is recognised during the diagnostics, appropriate measures must be taken to maintain the safety level.

2.4 Range of applications and certification

The servo drive with built-in safety module is a safety component in accordance with the EC Machinery Directive 2006/42/EC; the servo drive bears the CE marking. Safety-oriented standards and test values, which the product must comply with and fulfil, can be found in the section „Technical data“ (→ section 11). The product-relevant EU directives can be found in the declaration of conformity.

3 Product description

3.1 Supported devices

The SE-Power FS MOV safety modules can only be used in servo controllers in accordance with section 1.2. The servo controller of the SE-Power FS MOV series are in the default factory settings already with the SE-Power FS Safety Module MOV, with integrated functional for the safety functions STO, SS1, SS2, SOS, SLS, SSR, SSM, SBC, equipped.

3.2 Control sections and connections

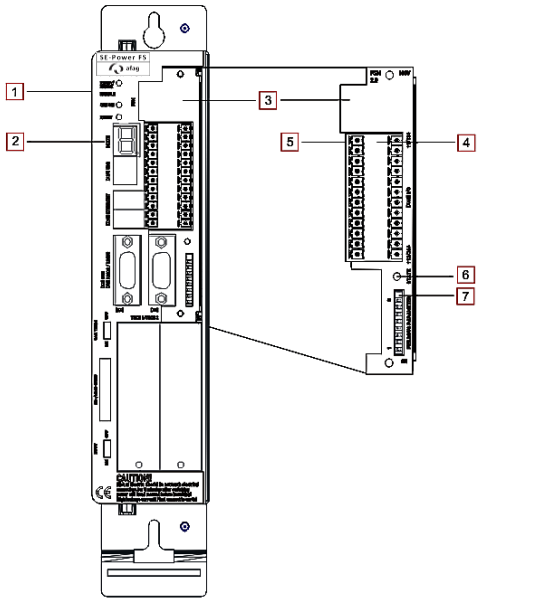

- 1 Servo controller SE-Power FS
- 2 7-segment display
- 3 SE-Power FS Safety Module MOV
- 4 I/O-interface [X40A] / [X40B]
- 5 Pin 1 of the interface [X40]
- 6 LED (operating status display)
- 7 DIP switch

Figure 1: Panel and connectors of the SE-Power FS Safety Module MOV

4 Function and application

The following figure shows a typical drive system with integrated functional safety technology, comprising the following components:

- servo drive SE-Power FS,
- SE-Power FS Safety Module MOV,
- synchronous servo motor,
- linear axis with second measurement system
- reliable brake unit.

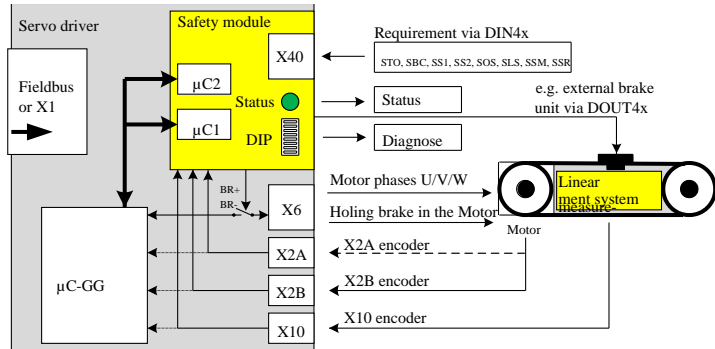

Figure 2: Safety module functional principle

5 Mounting / dismantling

The servo drive must be disconnected from all current-carrying cables before mounting and dismantling the safety module.

Warning
 Danger of electric shock if the safety module is not mounted.

Touching live parts causes severe injuries and can lead to death. Before touching live parts during maintenance, repair and cleaning work and when there have been long service interruptions:

1. Switch off power to the electrical equipment via the mains switch and secure it against being switched on again.
2. After switch-off, wait at least 5 minutes discharge time and check that power is turned off before accessing the servo drive.

Note

Incorrect handling can damage the safety module or servo drive.

- ❖ Switch off the supply voltage before mounting and installation work. Switch on supply voltage only when mounting and installation work are completely finished.
- ❖ Never unplug a module from, or plug a module into, the servo drive when powered!
- ❖ Observe the handling specifications for electrostatically sensitive devices. Do not touch the printed circuit board and the pins of the connector in the servo drive. Hold the safety module only by the front plate or the edge of the board.

5.1 Mounting the safety module

1. Insert the SE-Power FS Safety Module MOV into the empty slot for safety modules so that the board runs in the lateral guides of the slot.
2. Cautiously push in safety module. Make sure that it does not catch. When you have reached the rear contact strip within the servo drive, carefully press it into the contact strip until it stops.
3. Then screw the safety module with the two screws onto the front of the servo drive housing.

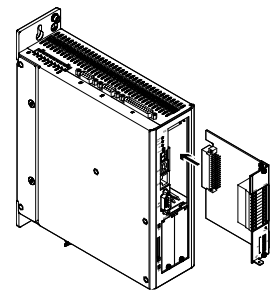

Figure 3: Mounting / Dismounting

Tighten the screws with 0,4 Nm ± 10% an.

5.2 Dismounting safety module

1. Unscrew screws on the safety module.
2. Loosen the safety module by gently levering it a few millimetres in the cut-outs on the upper right and lower right corner of the front cover or grip the safety module on the plugged in counter plug.
3. Pull the safety module out of the slot.

6 Electrical installation

6.1 Safety instructions

The requirements of EN 60204-1 must be fulfilled during installation.

Warning
 Danger of electric shock from voltage sources without protective measures.

❖ Use only PELV circuits in accordance with EN 60204-1 for the electric logic supply (protective extra-low voltage, PELV). Also take into account the general requirements for PELV circuits in accordance with EN 60204-1.

The cable is connected with two plugs. As a result, cables can remain plugged into the plugs when replacing the safety module, for example.

➔ Make sure that no jumpers, etc. can be used parallel to the safety wiring.

6.2 ESD protection

At unassigned plug connectors, there is the danger that damage may occur to the device or to other system parts as a result of ESD (electrostatic discharge). Earth the system parts before installation and use appropriate ESD equipment (e.g. shoes, earthing straps, etc.).

6.3 Connection [X40]

The SE-Power FS Safety Module MOV has a combined interface for control and acknowledgment via the plug connector [X40].

Pin	Designation	Plug	Pin	Designation
1	DIN40A		13	DIN41A
2	DIN40B		14	DIN41B
3	DIN42A		15	DIN43A
4	DIN42B		16	DIN43B
5	DOUT40A		17	DOUT41A
6	DOUT40B		18	DOUT41B
7	DIN44		19	DOUT42A
8	DIN45		20	DOUT42B
9	DIN46		21	C1
10	DIN47		22	C2
11	DIN48		23	GND24
12	DIN49		24	+24 V

7 Commissioning

Warning
 Loss of the safety function!

Lack of the safety function can result in serious, irreversible injuries, e.g. due to uncontrolled movements of the connected actuator technology.

- ❖ Operate the safety module only:
 - in a built-in condition and
 - when all safety measures have been implemented.
- ❖ Validate the safety function to complete commissioning.

Commissioning according to the EC Machinery Directive is the first intended use of the machine by the end customer. Here is meant start-up by the manufacturer during installation of the machine.

➔ Incorrect circuitry, incorrect configuration, use of an incorrect safety module or external components that were not selected according to the safety category, result in loss of the safety function.

- ❖ Carry out a risk assessment for your application and select the circuitry, configuration and components accordingly.

7.1 Prior to commissioning

Carry out the following steps in preparation for commissioning:

1. Ensure that the safety module is correctly mounted.
2. Check the electrical installation (connecting cable, pin allocation → section 6). Are all protective earth conductors connected?

7.2 DIP switch setting

Set the DIP switches as described in the documentation for the servo drives SE-Power FS or the corresponding fieldbus-specific product manuals.

7.3 Parameterisation with the Afag SE-Power ServoCommander

The servo drive must be completely parameterised prior to parameterisation of the safety module using SafetyTool. Additional information on commissioning of the servo drive can be found in the parameterisation software help or, possibly, in the Software manual.

7.3.1 Applying the safety module

When an engineering change is detected, e.g. a module replacement, a non-acknowledgeable error is triggered. To be able to place the application with the servo drive back in operation, the engineering change must be explicitly accepted or confirmed. Each exchange of a SE-Power FS Safety Module MOV, regardless of whether by an identical SE-Power FS Safety Module MOV or another module type (SE-Power FS Safety Module STO) must always be confirmed.

From the factory, you receive the safety module in the "delivery status":

- The safety module is "validated as a whole" with the parameterisation of the factory setting and is thus operational. The servo drive can be commissioned, and the output stage and controller enable can be set.
- All error messages due to a different parameterisation of the basic unit and safety module are suppressed. As a result, base commissioning of the servo drive is possible independently of complex safety-related peripherals.

Minimum circuitry in the delivery status:

- The safety functions STO and SBC are requested via DIN40.
- Restart takes place over DIN49, error acknowledgment over DIN48.

Wiring must not be bypassed and must be validated in the machine. The delivery status can also be recognised without parameterisation software or SafetyTool by the green-red flashing LED of the safety module (if DIN40 is switched on and no safety function is demanded).

7.4 Parameterisation of the safety module with the SafetyTool

Parameterisation of the safety module is then performed with special software, the SafetyTool. The SafetyTool is called up from the supplied parameterisation software. For additional information → SafetyTool Help.

7.5 Performance test, validation

→ Note

The safety functions must be validated after installation and after any changes to the installation.

This validation must be documented by the person performing commissioning. To help you with commissioning, you can find sample checklists in the document „SE-Power FS MOV-manual“.





8 Diagnostics and fault clearance

8.1 Status display





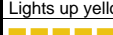
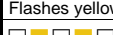

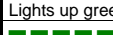
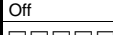
Status and malfunctions are displayed directly on the two-colour LED of the safety module.

8.1.1 Status display on the safety module

To display the status of the safety function, the safety module has an LED on its front. The status LED displays the operating status of the safety module. The display is exclusively for diagnostics and must not be used in a safety-oriented way.

LED	Status	Internal Status
Flashes red 	„System Fault“	The entire system is in the "System Fault" or "Communication Fault" status.
Lights up red 	„Safety Condition Violated“, error response initiated	Violation of at least one of the currently required safety functions.
Lights up yellow 	„Safe State reached“	Requested safety functions are in the status "Safe State Reached".
Flashes yellow 	„Safety Function Requested“	At least one safety function requested.
Flashes red/green 	„Delivery status“	Delivery status → section 7.3
Flashes green 	„Service“ status“	No parameters present, parameter invalid or parameterisation procedure is running.
Lights up green 	„Ready“, operational	Operational, no safety function requested, no errors.
Off 	„Initialization Running“	Initialization 1: Load parameter, Initialization 2: Establish communication.

8.1.2 Status display of the safety functions on the servo drive

Display of safety functions on the 7-segments display					
STO	S t O		SOS	S O S	
SS1	S S 1		USF0 (...1, 2, 3)	U S F 0	
SS2	S S 2		SBC	S b C	

8.2 Error messages

The servo drive indicates malfunctions cyclically in the seven-segment display on the front side of the servo drive. Error messages with "E" (for error), a main index (xx) and a sub-index (y) display, e.g. E 5 1 0. Warnings have the same number, but are represented with bars before and after, e.g. - 1 7 0 -. The following table lists the error messages that are relevant for functional safety in the context of the safety module.

→ The complete list of error messages can be found in the product manual of the servo drive used.

Error number	
Main index	Error type/class
Basic unit errors	
51-x	Control signals from the safety module, module type / identifier not OK
52-x	Error in activation sequence with the safety module
Errors of the safety module	
53-x	Violation of a safety function
54-x	Violation of a safety function
55-x	System error: Actual value recording / position encoder not OK
56-x	System error: Position recording / comparison not OK
57-x	System error: Inputs and outputs or internal test signals not OK
58-x	System error: Communication external / internal not OK
59-x	System error of the firmware / hardware error of the safety module

9 Operation

9.1 Obligations of the operator

The functionality of the safety device is to be checked at adequate intervals. It is the responsibility of the operator to choose the type of check and time intervals in the specified time period. The check is to be conducted so the flawless functioning of the safety device in interaction with all the components can be verified.

9.2 Maintenance and care

The safety module does not require any maintenance.

10 Repair, replacement of the safety module

10.1 Repair

→ Repair of the safety module is not permissible. If necessary, replace the complete safety module.

- ❖ Always replace the safety module in case of an internal defect. Send the unchanged defective safety module, including a description of the error and the application, back to Afag for analysis. Please contact your reseller to clarify the modalities of the return.

10.2 Replacement of the safety module

If a safety module fails and has to be replaced, organisational measures must be taken to ensure that an unsafe status is not created. This requires,

- that the safety module is not replaced by another module type with less function range (SE-Power FS Safety Module STO for SE-Power FS Safety Module MOV).
- that the revision status of the new safety module is identical with that of the old safety module or is compatible.
- that parameterisation of the new safety module is identical with the parameterisation of the defective safety module.

Observe required organizational measures to avoid errors in relationship with the module replacement. For example, you must always generate a new validation report due to the different serial number of the safety module.

10.2.1 Disassembly and installation

Before a module is replaced, compatibility between the safety module and basic unit must be checked.

Information on disassembling and installing the safety module can be found under „Mounting / dismantling“ → section 5.

10.2.2 Applying the safety module

After replacing the module, you must first accept the new safety module again.

→ section 7.

10.2.3 Commissioning again with the SafetyTool

After accepting the replaced safety module, you must transfer the desired parameterisation to the safety module and then validate. To do this, you must first start the SafetyTool in the online mode. You then have the following options, dependent on which data are present from the safety module to be replaced:

- Reliable parameter set available of the safety module to be replaced:
 - ❖ Open parameter set in the SafetyTool and load it to the safety module. Basic information of the basic unit must correspond to the parameter set.
- Stored SafetyTool project that conforms to the parameterisation present:
 - ❖ Set safety module to factory setting, if necessary.
 - ❖ Open SafetyTool project.
 - ❖ Adjust basic information of the basic unit, if they do not match.
 - ❖ Then validate parameter pages and load them to the safety module.
- If no stored data is available of the safety module to be replaced:
 - ❖ Set safety module to factory setting, if necessary.
 - ❖ Continue as with initial start-up.

Independent of the variant a), b) or c), you must generate a validation report again, with a new validation code and new serial number of the safety module. If there is no stored SafetyTool project, it should be made available by the machine manufacturer. After a replacement, a functional test is always required as well as validation based on the validation plan provided by the machine manufacturer.

10.3 Decommissioning and disposal

Observe the information for dismantling the safety module in section 5.

10.3.1 Disposal

Observe the local regulations for environmentally appropriate disposal of electronic modules. The safety module is RoHS-compliant.

The material used in the packaging has been specifically chosen for its recyclability.

11 Technical data

Safety Technology		
Safety indicators		
Safety functions	STO, SS1, SS2, SOS, SLS, SSR, SSM, SBC according to EN 61800-5-2	
SIL	SIL 3 ¹⁾	Safety Integrity Level according to EN 61800-5-2, EN 61508 and EN 62061
Category	4 ¹⁾	Category according to EN ISO 13849-1
Performance Level	PL e ¹⁾	Performance Level according to EN ISO 13849-1
1) Maximum achievable classification, limitations dependent on the safety function as well as circuitry and the encoders.		
MTTF _d [Years]	8700	Mean time to dangerous failure according to EN ISO 13849-1
PFH [h ⁻¹]	9,5 x 10 ⁻⁹	Probability of a dangerous, random hardware failure per hour according to EN 61800-5-2, EN ISO 13849-1, EN 62061 and EN 61508
DC [%]	97,5	Diagnostic coverage according to EN 61800-5-2, EN 61508 and EN ISO 13849-1 and EN 62061
HFT	1	Hardware fault tolerance according to EN 61800-5-2, EN 62061 and EN 61508
SFF [%]	99,5	Safe failure fraction according to EN 61800-5-2, EN 62061 and EN 61508
T [Years]	20	Test interval according to EN 61800-5-2, EN 61508 and EN 62061
T _M [Years]	20	Duration of use according to EN ISO 13849-1
Safety information		
Type examination	The functional safety technology of the product has been certified in accordance with section 1.4 by an independent testing centre.	
Certificate issuing authority	TÜV Rheinland, Certification Body of Machinery, NB 0035	
Certificate no.	01/205/5443.00/15	
Approved component	yes	

General		
Mechanical		
Dimensions (L x B x H) [mm]	112,2 x 99,1 x 28,7	
Weight [g]	ca. 220	
Note of materials	RoHS-compliant	
Certifications (Safety module FSM 2.0 – MOV for servo drive SE-Power FS)		
CE marking (see declaration of conformity)	In accordance with EU EMC Directive	
	In accordance with EU Machinery Directive	
The device is intended for use in an industrial environment. Measures may need to be implemented in residential areas for interference suppression.		

Operating and environmental conditions				
Transport				
Admissible temperature range [°C]	-25 ... +70			
Humidity [%]	0 ... 95, at max. 40 °C ambient temperature			
Maximum duration of transport [Weeks]	maximal 4 throughout the product life cycle			
Storage				
Admissible temperature range [°C]	-25 ... +55			
Humidity [%]	5 ... 95, non-condensing / protected against condensation			
Admissible height [m]	< 3000 (above sea level)			
Ambient conditions SE-Power FS with SE-Power FS Safety Module MOV in the FSM slot				
	SE-Power FS	1kVA	3kVA	6kVA
Ambient temperature [°C]	0 ... +40	0 ... +40	0 ... +40	0 ... +40
Ambient temperature with power reduction [°C]	+40 ... +50	+40 ... +50	+40 ... +50	+40 ... +45
Humidity [%]	0 ... 90 (non-condensing).			No corrosive media permitted in the environment of the device.
Admissible setup altitude above sea level				
with nominal power [m]	1000			
with power reduction [m]	1000 ... 2000			
Protection category	IP20 (mounted in the SE-Power FS).			
Vibration / shock	Requirements of EN 61800-5-1 and EN 61800-2 are fulfilled.			
Electrical operating conditions				
Galvanically insulated potential areas	Control voltage of the basic unit.			
	24 V control voltage (all inputs and outputs).			
	Potential-free signal contact C1/C2.			
System voltage [V]	< 50 (24 V PELV- power supply in accordance with EN 60204-1).			
Overvoltage category in accordance with EN 61800-5-1	3			
Degree of contamination in accordance with EN 61800-5-1	2			
This must always be ensured through appropriate measures, e.g. through installation in a control cabinet.				
EMC operating conditions				
Resistance to interference	Requirements for "second environment" in accordance with EN 61800-3 (PDS of category C3) requirements in accordance with EN 61326-3-1			
Emitted interference	Requirements for "first environment with restricted availability" in accordance with EN 61800-3 (PDS of category C2)			

Electrical data	
Digital inputs DIN40A/B to DIN43A/B and DIN44 to DIN49	
Input	Type 3 in accordance with IEC 61131-2
Nominal voltage [V DC]	24
Admissible voltage range [V]	-3 ... 30
Digital outputs DOUT40A/B to DIN42A/B	
Output	High side switch with pull-down
Voltage range [V DC]	18 ... 30
Admissible output current I _{L, nominal} [mA]	< 50
Signal contact C1/C2	
Modality	Relay contact, normally open
Voltage range [V DC]	18 ... 30
Output current I _{L, nominal} [mA]	< 200
Short circuit / overcurrent protection	Not short circuit proof, overvoltage-resistant up to 60 V
Service life of acknowledgment [n _{op}]	10 x 106 (at 24 V and I _{Contact} = 10 mA, the service life is reduced with higher load currents)
24V auxiliary voltage	
Modality	Logic supply voltage routed over the servo drive (fed in at [X9], not additionally filtered or stabilised). Reverse-polarity protected, overvoltage-proof up to 60 V DC
Nominal voltage [V]	24
Output current I _{L, nominal} [mA]	100
Cabling [X40]	
Max. cable length [m]	< 30
Shielding	When wiring outside the control cabinet, use screened cable. Guide shielding into the control cabinet / attach to the side of the control cabinet
Conductor cross-section (flexible conductor, Ferrules with insulating collar)	
one conductor [mm ²]	0,25 ... 0,5
two conductor [mm ²]	2 x 0,25 (with twin wire end ferrules)
Tightening torque of counter plug [Nm]	0,22 ... 0,25