

## Assembly and operating instructions

# Electric slide ES12



### Translation of the Original Assembly Instructions EN

- ES-12-20 ⇒ Order no.: 50433802
- ES-12-60 ⇒ Order no.: 50433803
- ES-12-100 ⇒ Order no.: 50433804

**Dear Customer,**

Thank you for choosing our products and placing your trust and confidence in our company!

These assembly and operating instructions contain all essential information you need about your product. Our aim is to provide the required information as concisely and clearly as possible. If, however, you still have any questions on the contents or suggestions, please do not hesitate to contact us. We are always grateful for any feedback.

Our team will also be glad to answer any further question you may have regarding the electric slide or other options.

We wish you every success with our products!

With kind regards

*Your Afag team*

**© Subject to modifications**

The electric slides have been designed by Afag Automation AG according to the state of the art. Due to the constant technical development and improvement of our products, we reserve the right to make technical changes at any time.

**Updates of our documentations**

---



Unlike the printed documents, our digital instructions manuals, product data sheets and catalogues are being continuously updated on our website.

Please keep in mind that the digital documents on our website are always the latest versions.

---

**© Copyright 2021 Afag Automation AG**

All contents of the present assembly and operating instructions, in particular the texts, photographs and graphics, are protected by copyright. All rights reserved. No part of these assembly and operating instructions may be reproduced, distributed (made available to third parties), or transmitted in any form or by any means, including photocopying, recording, or other electronic or mechanical methods, without the prior written permission of Afag Automation AG.

**Afag Automation AG**  
**Luzernstrasse 32**  
**CH-6144 Zell (Schweiz)**  
Tel.: +41 62 959 86 86  
e-mail: sales@afag.com  
Internet: www.afag.com

## Table of contents

<b>1</b>	<b>General</b> .....	<b>5</b>
1.1	Contents and purpose of these assembly instructions.....	5
1.2	Explanation of symbols.....	5
1.3	Additional symbols.....	6
1.4	Applicable documents .....	7
1.5	Warranty .....	7
1.6	Liability.....	7
<b>2</b>	<b>Safety instructions</b> .....	<b>8</b>
2.1	General .....	8
2.2	Intended use.....	8
2.3	Foreseeable misuse .....	8
2.4	Obligations of the operator and the personnel .....	9
2.4.1	Observe the assembly instructions .....	9
2.4.2	Obligations of the operating company.....	9
2.4.3	Obligations of the personnel .....	10
2.5	Personnel requirements .....	10
2.5.1	Personnel qualification .....	10
2.6	Personal protective equipment (PPE) .....	11
2.7	Changes & modifications.....	11
2.8	General hazards / residual risks.....	12
2.8.1	General hazards at the workplace .....	12
2.8.2	Danger due to electricity .....	13
2.8.3	Danger due to strong magnetic fields .....	13
2.8.4	Danger due to high temperatures .....	13
2.8.5	Mechanical hazards .....	13
<b>3</b>	<b>Technical data</b> .....	<b>14</b>
3.1	Electric slide ES12.....	14
3.1.1	Dimensional drawing ES12 .....	14
3.1.2	Technical data ES12 .....	15
3.1.3	Preferred combinations ES12 .....	16
3.1.4	Module stresses ES12 .....	17
<b>4</b>	<b>Transport, packaging and storage</b> .....	<b>18</b>
4.1	Safety instructions for transport.....	18
4.2	Scope of supply .....	18
4.3	Transport .....	19
4.4	Packaging.....	19
4.5	Storage .....	19
<b>5</b>	<b>Structure and description</b> .....	<b>20</b>
5.1	Design electric slides.....	20
5.2	Product description.....	20

5.3	Accessories .....	21
5.3.1	Servo controller .....	21
5.3.2	Technical data servo controllers .....	22
5.3.3	Controllers, cables, plugs .....	25
5.3.4	Cable types .....	27
<b>6</b>	<b>Installation, assembly and setting .....</b>	<b>29</b>
6.1	Safety Instructions for installation and assembly .....	29
6.2	Assembly and attachment .....	30
6.2.1	Mounting holes .....	30
6.2.2	Centering bushing .....	31
6.2.3	Tightening torques .....	32
6.2.4	Mounting (slide) .....	32
6.2.5	Mounting (basic element) .....	32
6.3	Programming of the electric slides .....	33
6.3.1	Safety instructions for programming .....	33
6.3.2	Programming .....	33
<b>7</b>	<b>Commissioning .....</b>	<b>34</b>
7.1	Safety instructions for commissioning .....	34
7.2	Preparatory activities for commissioning .....	35
7.3	Commissioning of the modules .....	35
7.4	Setting up & retrofitting .....	36
<b>8</b>	<b>Fault elimination .....</b>	<b>37</b>
8.1	Safety instructions for troubleshooting .....	37
8.2	Fault causes and remedy .....	37
<b>9</b>	<b>Maintenance and repair .....</b>	<b>38</b>
9.1	General notes .....	38
9.2	Safety instructions for maintenance and repair .....	38
9.3	Maintenance activities and maintenance intervals .....	39
9.3.1	Overview of the maintenance points .....	39
9.3.2	Further maintenance .....	39
9.4	Spare parts and repair work .....	40
<b>10</b>	<b>Decommissioning and disposal .....</b>	<b>41</b>
10.1	Safety instructions for decommissioning and disposal .....	41
10.2	Decommissioning .....	41
10.3	Disposal .....	41
<b>11</b>	<b>Declaration of incorporation .....</b>	<b>42</b>

## 1 General

### 1.1 Contents and purpose of these assembly instructions

These assembly instructions contain important information on assembly, commissioning, functioning and maintenance of the electric slide to ensure safe and efficient handling of the electric slide ES12.

Consistent compliance with these assembly instructions will ensure:

- permanent operational reliability of the electric slide,
- optimal functioning of the electric slide,
- timely detection and elimination of defects (thereby reducing maintenance and repair costs),
- prolongation of the electric slide's service life.

The illustrations in this manual shall provide you with a basic understanding of the module and may vary from the actual design of your module.

### 1.2 Explanation of symbols

The safety notes are marked by a pictogram and a signal word. The safety notes describe the extent of the hazard.

#### DANGER



#### **Danger!**

This safety note indicates an imminently hazardous situation which, if not avoided, will result in death or serious injury.

#### WARNING



#### **Warning!**

This safety note points out a potentially hazardous situation which, if not avoided, could result in death or serious injury.

#### CAUTION



#### **Caution!**

This safety note points out a potentially dangerous situation which, if not avoided, can result in minor or slight injuries.

#### NOTICE

This safety note points out a potentially dangerous situation which, if not avoided, can cause substantial damage to property and the environment.



This note contains important additional information as well as useful tips for safe, efficient and trouble-free operation of the electric slide.

**Further warning signs:**

Where applicable, the following standardised symbols are used in this manual to point out the various potential health risks.

	Warning - Dangerous electrical voltage.
	Warning - Risk of injury from contact with hot surfaces.
	Warning - Risk of hand and finger injury due to uncontrolled movements of components.
	Warning - Magnetic field.
	Warning - Back injury due to heavy lifting.
	Warning - Risk of injury as a result of parts being flung out!
	Warning - High noise levels.

**1.3 Additional symbols**

In these assembly instructions the following symbols are used to highlight instructions, results, references, etc.

Symbol	Description
1.	Instructions (steps ...)
⇒	Results of actions
↻	References to sections
■	Enumerations not ordered

### 1.4 Applicable documents



Each electric slide is accompanied by a safety information sheet. This information sheet must be read carefully by every person who carries out work on and with the electric slides.

### 1.5 Warranty

The warranty terms for Afag handling components and handling systems are the following:

- 24 months from initial operation and up to a maximum of 27 months from delivery.
- Wear parts are excluded from the warranty (*The customer is entitled to a product free of defects. This does also apply to defective accessories and wear parts. Normal wear and tear are excluded from the warranty*).

The warranty covers the replacement or repair of defective Afag parts. Further claims are excluded.

#### **The warranty shall expire in the following cases:**

- Improper use of the module
- Non-observance of the instructions regarding assembly, commissioning, operation and maintenance of the module.
- Improper assembly, commissioning, operation and maintenance
- Repairs and design changes carried out without prior technical instructions of Afag Automation AG
- Removing the serial number from the product
- Inadequate checking of wear parts
- Non-observance of the EC Machinery Directive, the Accident Prevention Regulations, the Standards of the German Electrotechnology Association (VDE) and these safety and assembly instructions.

### 1.6 Liability

No changes shall be made to the electric slides unless described in this instructions manual or approved in writing by Afag Automation AG.

Afag Automation AG accepts no liability for unauthorized changes or improper assembly, installation, commissioning, operation, maintenance or repair work.

## 2 Safety instructions

### 2.1 General

This chapter provides an overview of all important safety aspects to ensure safe and proper use of the electric slide and optimal protection of personnel.

Safe handling and trouble-free operation of the electric slides requires knowledge of the basic safety regulations.

Every person carrying out installation, commissioning, maintenance work or operating the ES modules must have read and understood the complete user manual, especially the chapter on safety instructions.

Also observe all rules and regulations regarding accident prevention applicable to the place of installation of the modules.

Improper use may result in danger to life and limb of the user or third parties or in damage to the automation system or other material assets.



Failure to follow the directions and safety instructions given in this instructions manual may result in serious hazards.

---

### 2.2 Intended use

The ES electric slides series is designed for the shock-free linear movement of permanently mounted loads in **non-explosive** environments and in the ambient and operating specially conditions defined for these modules.

The electric slides are used in automation systems.

The electric slides are exclusively intended for operation with original LinMot components (controller, cables ...).

Any use beyond the described purpose is considered to be not in accordance with the intended use.



The intended use of the module also includes:

- observance of all instructions given in this instructions manual,
  - compliance with the inspection and maintenance work and the specifications in the data sheets,
  - using only original spare parts.
- 

### 2.3 Foreseeable misuse

Any use other than or beyond the intended use described above is considered a misuse/improper use of the electric slides.

**Especially the following use is considered a misuse:**

- Use in potentially explosive atmospheres



## WARNING



### Risk of injury if the module is not used as intended!

The improper use of the electric slides poses a potential hazard to the personnel.

- The electric slides may only be used in a technically perfect condition in accordance with their intended use and instructions in this manual as well as in compliance with the safety requirements!
- Any malfunctions, particularly those that could impair safety, must be eliminated immediately!



Risks can occur if the module is not used as intended. In the event of damages caused by improper use the following shall apply:

- the operating company shall be solely responsible for such damage, and
- AFAG does not accept any liability for damages caused by improper use.

## 2.4 Obligations of the operator and the personnel

### 2.4.1 Observe the assembly instructions

A basic prerequisite for safe and proper handling of the parallel gripper is a good knowledge of the basic safety instructions.



These assembly instructions, in particular the safety instructions contained therein, must be observed by all persons working with the electric slides.

### 2.4.2 Obligations of the operating company

In addition to the safety instructions given in this manual, the operating company must also comply with the safety, accident prevention and environmental protection regulations valid for the field of application of the electric slides.

The operating company is required to use only personnel who:

- have the necessary professional qualifications and experience,
- are familiar with the basic rules regarding occupational safety and accident prevention,
- have been instructed in the correct handling of the electric slides,
- have read and understood these assembly instructions.

**The operating company is also required to:**

- monitor on an ongoing basis that the personnel work safely considering any potential hazard involved and the assembly instructions are observed,
- ensure that the assembly instructions are always kept at hand at the automation system in which the electric slides have been integrated,
- observe and communicate universally applicable laws and regulations regarding accident prevention and environmental protection,
- provide the necessary personal protective equipment (e.g. protective gloves) and instruct the personnel to wear it.

### 2.4.3 Obligations of the personnel

All personnel working with the electric slides are required to:

- read and observe these assembly instructions, especially the chapter on safety,
- observe the occupational safety and accident prevention regulations,
- observe all safety and warning signs on the electric slides,
- refrain from any activity that might compromise safety and health.



In addition, the personnel must wear the personal protective equipment required for carrying out their work. (👉 Chapter 2.6).

## 2.5 Personnel requirements

### 2.5.1 Personnel qualification

The activities described in the assembly instructions require specific requisites at the level of professional qualifications of the personnel.

Personnel not having the required qualification will not be able to assess the risks that may arise from the use of the electric slides thus exposing himself and others to the risk of serious injury. Therefore, only qualified personnel may be permitted to carry out the described activities on the electric slides.

Persons whose ability to react is restricted due to the intake of medication or the like must not interact with the electric slides.

These installation instructions are intended for skilled personnel (installers, system integrators, maintenance personnel, technicians), electricians and operating personnel.

The following is a description of the professional skills (qualifications) required for carrying out the different activities:

#### Qualified personnel:

Qualified personnel with appropriate training who are qualified due to their special know-how and fully familiar with the machine and who have been given instructions on how to carry out the task entrusted to them safely.

#### Qualified electrician:

Persons who have obtained their electrical qualifications through appropriate professional training and complementary courses that enables them to identify risks and prevent possible hazards resulting from electricity.

#### Operator (trained personnel):

Authorized persons who due to their specialized professional training, expertise and experience are capable of identifying risks and preventing possible hazards arising from the use of the machine.





## 2.6 Personal protective equipment (PPE)

The personal protective equipment serves to protect the personnel from hazards affecting their safety and health at work.

When working on/with the electric slides, the personnel must wear the personal protective equipment assigned by the safety officer of the operating company or as required by safety regulations. In addition, the personnel are required to:

- wear the personal protective equipment provided by the operating company (employer),
- check the personal protective equipment for proper condition, and
- immediately notify the person responsible on site of any defects found on the personal protective equipment.

Personal protective equipment and the respective mandatory signs:

	<p><i>Protective clothing</i> is a close-fitting clothing specifically designed to protect personnel from hazards during work.</p>
	<p><i>Protective gloves</i> are specifically designed to protect the personnel against hand injuries (such as cuts, abrasion, burns).</p>
	<p><i>Safety shoes</i> are specifically designed to protect the personnel against foot injuries from crushing, falling objects or slipping on slippery surfaces.</p>
	<p>Hearing protectors are required to protect the personnel against excessive noise levels to prevent noise-induced hearing loss.</p>

## 2.7 Changes & modifications

No changes may be made to the electric slides which have not been described in these assembly instructions or approved in writing by Afag Automation AG.

AFAG Automation AG accepts no liability for unauthorised changes or improper assembly, installation, commissioning, maintenance or repair work.



The electric slides may not be changed or modified in any way, except with the prior written consent of AFAG Automation AG.

## 2.8 General hazards / residual risks

Despite the safe design of the electric slides and the technical protective measures taken, there still remain residual risks that cannot be avoided and which present a non-obvious residual risk when operating the electric slides.

Observe the safety instructions in this chapter and in the other sections of this manual to avoid damage to property and dangerous situations for the personnel.

### 2.8.1 General hazards at the workplace

The electric slides have been built according to the state-of-the-art and the applicable health and safety requirements. Nevertheless, improper use of the electric slides may cause the following hazards to the personnel:

- danger to life and limb of the operator or third parties,
- on the electric slides themselves,
- property damage.



Always keep the assembly instructions ready at hand at the workplace! Please, also observe:

- the general and local regulations on accident prevention and environmental protection.
- Observe the safety information sheet for the electric slide.

#### WARNING



#### **Danger - Do not use in unsuitable environment!**

The electric slides are designed for use in **non**-explosive atmospheres.

- Do **not** use the electric slides in potentially explosive atmospheres!

#### CAUTION



#### **Risk of injuries due to uncontrolled parts movements!**

When connecting the electric slides to the control unit or when operating the electric slides sudden, unexpected movements may occur which can cause personal injury or property damage.

- Only qualified personnel may work with or on the electric slides.
- Read the assembly instructions carefully before carrying out any work on or with the electric slides.

### 2.8.2 Danger due to electricity

#### WARNING



##### **Danger! Risk of electric shock!**

If work on electrical components is required, ensure that the work is carried out properly, failure to do so will cause serious or fatal injuries.

- Work on the machine's electrical equipment may only be performed by skilled electrician or trained personnel under the supervision of a skilled electrician in accordance with all relevant electrical regulations.
- 

### 2.8.3 Danger due to strong magnetic fields

#### DANGER



##### **Danger due to magnetic fields!**

Due to the strong magnetic fields, electronic devices such as pacemakers can be disturbed or their function impaired.

Persons with a pacemaker must keep a safety distance of at least 50 cm.

---

### 2.8.4 Danger due to high temperatures

#### CAUTION



##### **Danger of injury from hot surfaces!**

During continuous operation of the electric slide, the surface of the slide heats up.

- Before touching hot surfaces without protective gloves, make sure they have cooled down to ambient temperature.
- 

### 2.8.5 Mechanical hazards

#### CAUTION



##### **Danger of injury from moving components!**

Limbs can be crushed by moving components!

- Work on and with the electric slides may only be carried out by qualified personnel.
  - Never reach into the system during normal operation!
-

### 3 Technical data

#### 3.1 Electric slide ES12

##### 3.1.1 Dimensional drawing ES12

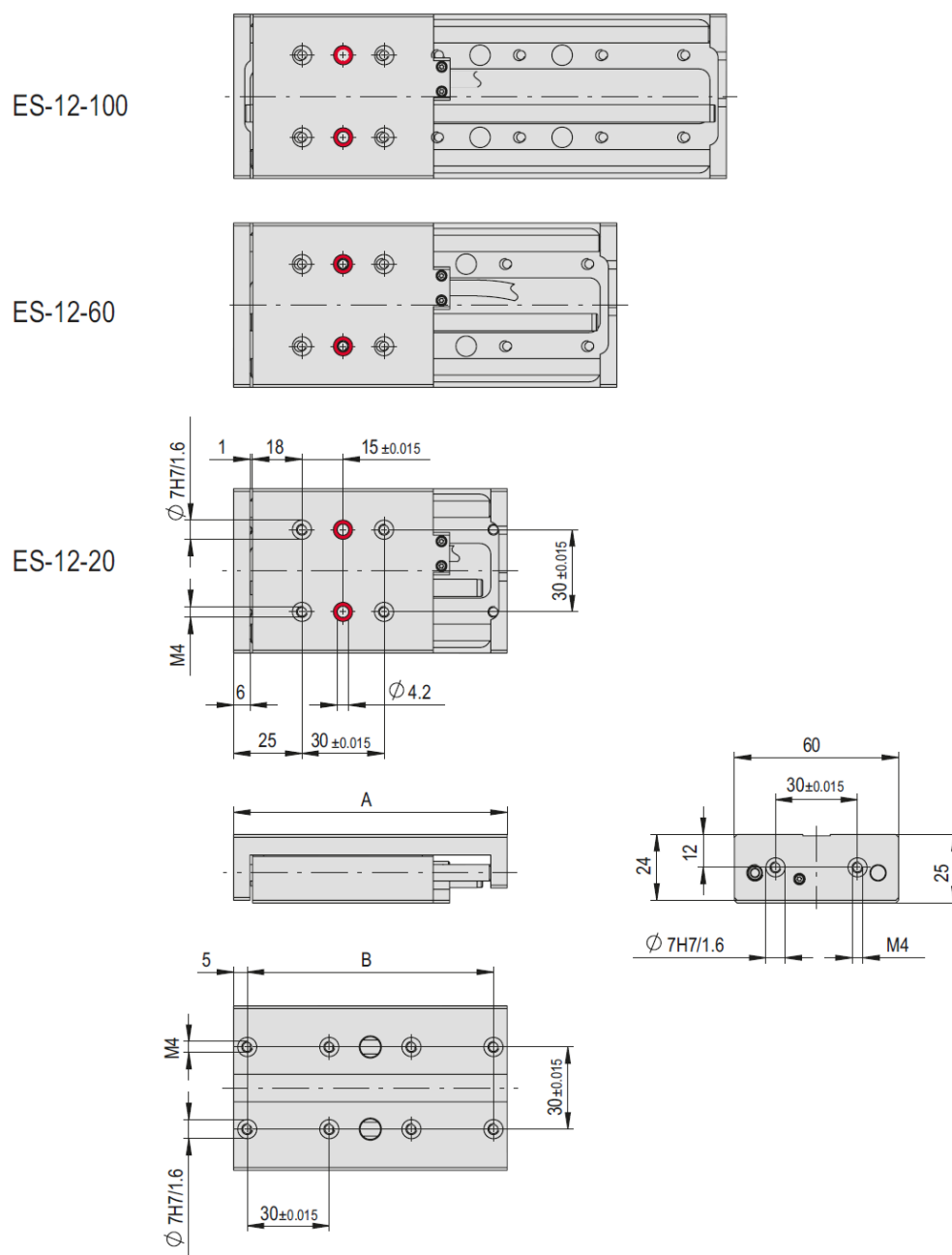

Bores can be screwed through

Fig. 1 Dimensional drawing of electric slide ES12

## Technical data

### 3.1.2 Technical data ES12

ES12	
Attachment grid	30 x 30 mm
Attachment thread	M4
Attachment thread alternative	M3
Operating temperature	10 - 40 °C
Storage temperature	10 - 40 °C
Humidity	< 90 %

Type	ES12-20	ES12-60	ES12-100
<b>Order number</b>	<b>50433802</b>	<b>50433803</b>	<b>50433804</b>
Stroke H	20 mm	60 mm	100 mm
Net weight	0.331 kg	0.368 kg	0.403 kg
Moving weight	0.126 kg	0.163 kg	0.199 kg
Nominal voltage	< 75 VDC	< 75 VDC	< 75 VDC
Drive	Linear motor, electric		
Protection type	IP 30	IP 30	IP 30
Peak force Fx	10.7 N	10.7 N	10.7 N
Force constant	6.43 N/A	6.43 N/A	6.43 N/A
Permanent force	3.6 N	3.6 N	3.6 N
Peak force	10.7 N	10.7 N	10.7 N
Repeat accuracy	+/- 0.02 mm	+/- 0.02 mm	+/- 0.02 mm
Mounting position	↔	↔	↔

Cleanroom class ISO 14644-1, class ISO 7

\*Vertical installation upon request

#### Included in the delivery (Catalogue HT accessories)

- 2x Centering bushing Ø7x3
- 4x Mounting screw M4x22

#### Accessories

(Catalogue HT accessories)

- Adapter ES8/12 LinMot
- Motor cable-M16
- Controller C1xxx-1S
- Plug kit for C1xxx-1S
- USB-RS232 Converter for controllers

#### Alternative accessories

(Catalogue HT accessories)

- Additional motor cables
- Additional controllers

## 3.1.3 Preferred combinations ES12

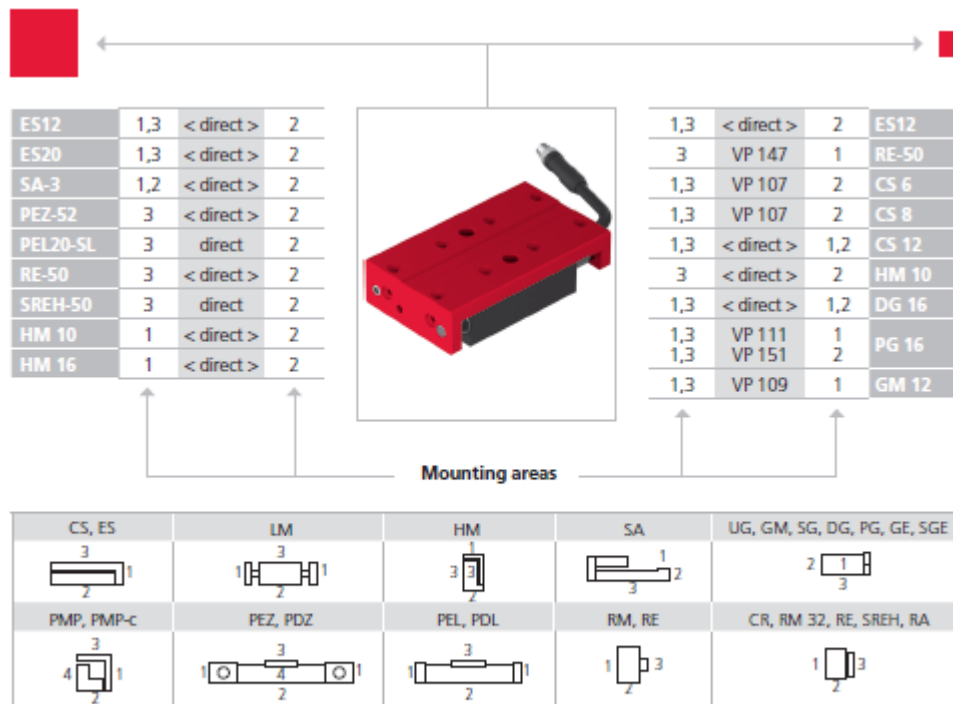

Note that there might be different mounting positions from one module to another one.

The required connection elements and the range of support columns are depicted in the catalogue HT accessories.



## Technical data

### 3.1.4 Module stresses ES12

Type	ES12-20	ES12-60	ES12-100
Max. static torque Mx	10 Nm	10 Nm	10 Nm
Max. static torque My	10 Nm	10 Nm	10 Nm
Max. static torque Mz	10 Nm	10 Nm	10 Nm
Max. dynamic torque Mx	0.5 Nm	0.5 Nm	0.5 Nm
Max. dynamic torque My	0.5 Nm	0.5 Nm	0.5 Nm
Max. dynamic torque Mz	0.5 Nm	0.5 Nm	0.5 Nm
Peak force Fx	10.7 N	10.7 N	10.7 N

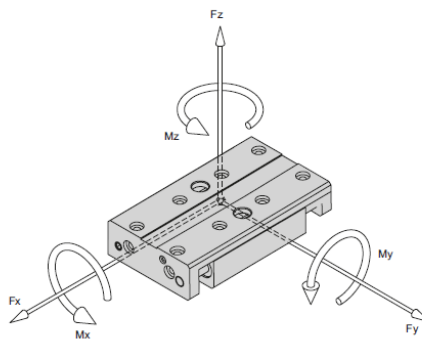

Maximum payload/type	ES12-20	ES12-60	ES12-100
Installation position (horizontal) for mounting side 1/3	0.2 kg	0.2 kg	0.2 kg

Assembly sides module mounting horizontal:

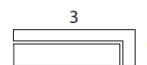

### Operation time diagrams

#### Operation time ES12

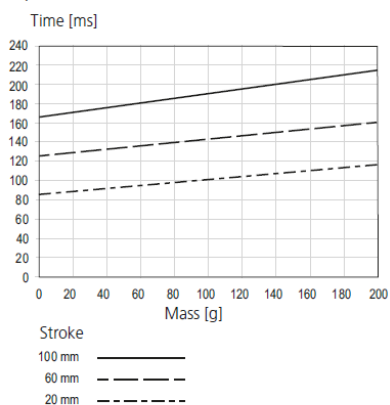

Fig. 2 Loads electric slides

## 4 Transport, packaging and storage

### 4.1 Safety instructions for transport



#### CAUTION

##### Risk of injury when packing and unpacking the electric slides!

The electric slides can be moved back and forth while they are still loose and cause crushing injuries.

- Pack and unpack the electric slides carefully.



Also observe the safety instructions in  chap. 2 „Safety instructions“ in this manual.

### 4.2 Scope of supply



In addition to the assembly and operating instructions, a safety information sheet is enclosed with each electric slide.

This information sheet must be read by every person who carries out work with and on the electric slides!



Fig. 3 Scope of delivery electric slide ES8 and ES12

Unt.	ES12
1 x	Module ES12
2 x	Centering bushing $\varnothing$ 7x3
2 x	Mounting screws M4x22
1 x	Mounting/operating instructions

### 4.3 Transport



---

No liability can be assumed for damages caused by improper installation on the part of the operating company.

---



---

The following conditions must be complied with for transport and storage:

- Storage temperature: 0-50 °C
  - Relative air humidity: < 90%, non condensing
- 

### 4.4 Packaging

The electric slides are transported in the transport packaging of AFAG Automation AG. If no AFAG packaging used, the electric slides must be packed so that they are protected against shock and dust.

#### NOTICE

##### **Risk to the environment due to incorrect disposal of the packaging material**

Environmental damage can be caused by incorrect disposal of the packaging material.

- Dispose of the packaging material in an environmentally sensitive way in accordance with the local environmental regulations.
- 

### 4.5 Storage

If the electric slides are stored for an extended period of time, observe the following:

- Store the electric slides in the transport packaging
- Do not store the electric slides outdoors or expose them to weather conditions.
- The storage space must be dry and dust free.
- Room temperature of the storage space: 0-50 °C.
- Relative air humidity: < 90% non condensing.
- Clean the electric slides and protect the blank metal parts against corrosion using the appropriate means.
- Protect the electric slides from dirt and dust.

## 5 Structure and description

### 5.1 Design electric slides

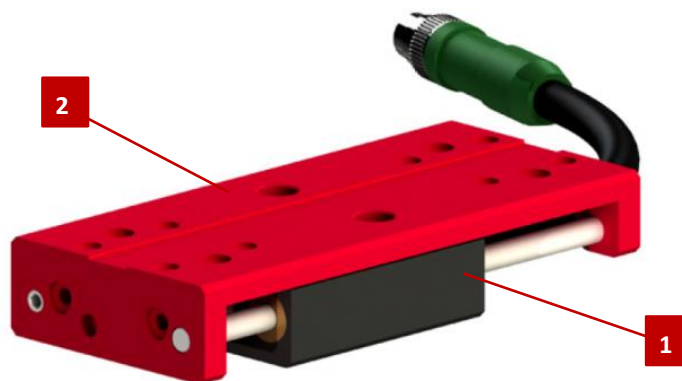

Fig. 4 Design of the electric slide (example ES8)

- 1. Base element
- 2. Slide

### 5.2 Product description

The electric slides are electric modules with a contactless and wear-free direct drive (linear motor).

Electric slides are used in automation systems and serve to move permanently mounted loads. The electric slides are designed for use in **non** explosive atmospheres.

The electric slides are designed for operation with original LinMot components.

### 5.3 Accessories

#### 5.3.1 Servo controller

Modules	SE-24	SE-Power 1kVA	SE-Power 3kVA	SE-Power 6kVA	C11xx	C12xx	E12xx	E14xx	Third party controllers
<b>Catalogue HT linear</b>									
ES12					Standard	Alternative			
ES20					Standard	Alternative			
ES30					Standard	Alternative			
ES40/-HP					Standard	Alternative			
SA-1/-FL		Standard			Alternative				
SA-3/-FL		Standard			Alternative				
SA-6/-FL		Standard			Alternative				
PEZ-52		Standard			Alternative				
PEZ-65		Standard			Alternative				
PEZ-80		Alternative	Standard	Alternative					
PEZ-100		Alternative	Standard	Alternative					
PDZ-128		Standard	Alternative	Alternative	Alternative				
PDZ-160		Alternative	Standard	Alternative	Alternative				
PDZ-200		Alternative	Standard	Alternative	Alternative				
PEL20/-SL					Standard	Alternative			
PDL30					Standard	Alternative			
PDL40/-HP					Standard	Alternative			
<b>Catalogue HT gripping &amp; turning</b>									
RE-50		Standard							
RE-50 18-100V	Alternative	Standard			Standard	Alternative			
RE-75		Standard							
RE-75 18-100V A		Standard			Standard	Alternative			
SE20					Standard	Alternative			
SE30					Standard	Alternative			
RA-40					Standard	Alternative			
SG-50	Standard								
SG-50-ABq					Standard	Alternative			

The servo controllers (except the third party controllers) are servo position controllers that are specifically tailored to all Afag modules and axes. They provide you, the user, with extremely short commissioning times and simple, practical handling. The effort required for system integration is reduced to a minimum because all modules and axes are parametrised ex works, and processed to ensure optimal operation.

Note: In order to be connected to third party controllers, all cables are also available with open ends. If you have any questions, please contact your sales partner.

 Standard  
 Alternative

Fig. 5 Overview of servo controllers

**5.3.2 Technical data servo controllers**
**Controller C11xx**

C11xx	
Operating temperature	0 - 40 °C
Bearing temperature	-25 - 70 °C
Humidity	< 90 %

Type	C1100 CanOpen STO	C1150 EtherCat STO	C1150 Profinet PN STO
<b>Order number</b>	<b>50419402</b>	<b>50419403</b>	<b>50419404</b>
Net weight	0.7 kg	0.7 kg	0.7 kg
Dimensions W x H x D	26.6x206x106 mm	26.6x206x106 mm	26.6x206x106 mm
Nominal output current	25 A	25 A	25 A
Supply voltage	24 - 72 VDC	24 - 72 VDC	24 - 72VDC
Control voltage	24 VDC	24 VDC	24 VDC
Protection type	IP 20	IP 20	IP 20
Intermediate circuit voltage	24 - 80 VDC	24 - 80 VDC	24 - 80 VDC
Programming interface	RS 232	RS 232	RS 232

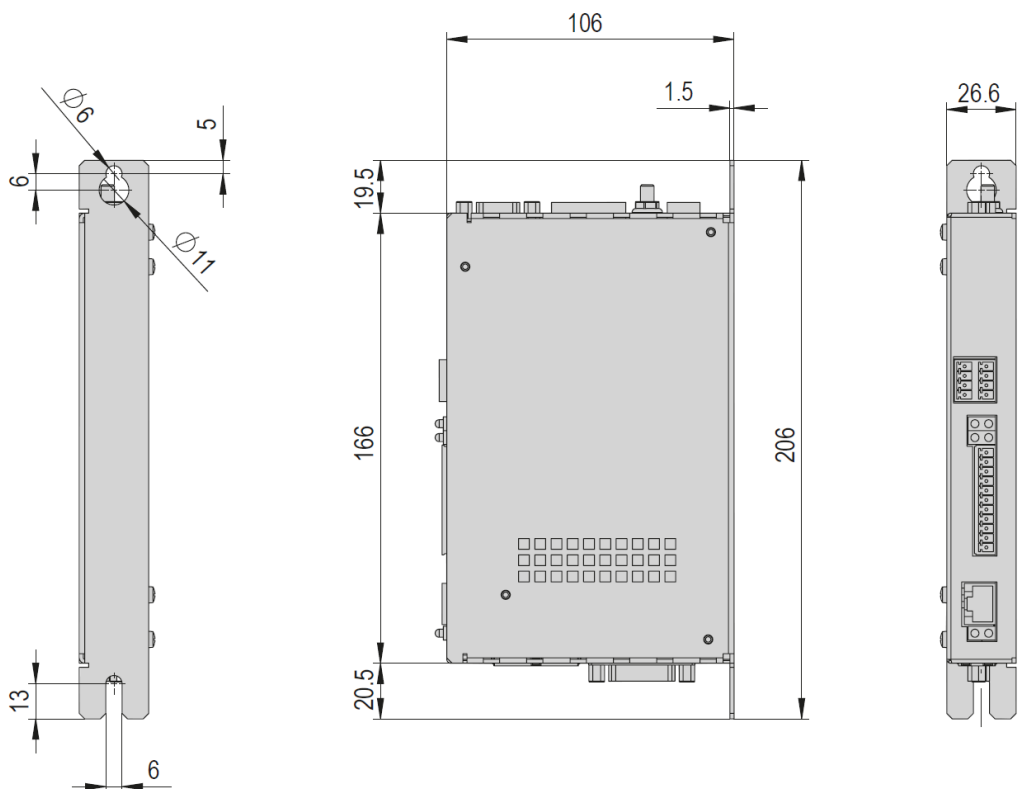
**Included in the delivery**

- 1x Plug kit for C1xxx-1S

**Accessories**

- Power supply S01-72/500, 1-phase
- Motor plug for controller C1x00
- USB-RS232 Converter for controllers

**Alternative Accessories**

- Additional power supplies

### Controller C12xx

C12xx		
Operating temperature	0 - 40 °C	
Bearing temperature	-25 - 70 °C	
Humidity	< 90 %	
Type	C1250 EtherCat STO	C1250 Profinet PN STO
<b>Order number</b>	<b>50419400</b>	<b>50419401</b>
Net weight	0.7 kg	0.7 kg
Dimensions W x H x D	25.3x216x106 mm	25.3x216x106 mm
Nominal output current	25 A	25 A
Supply voltage	24 - 72 VDC	24 - 72 VDC
Control voltage	24 VDC	24 VDC
Protection type	IP 20	IP 20
Intermediate circuit voltage	24 - 80 VDC	24 - 80 VDC
Programming interface	RS 232	RS 232

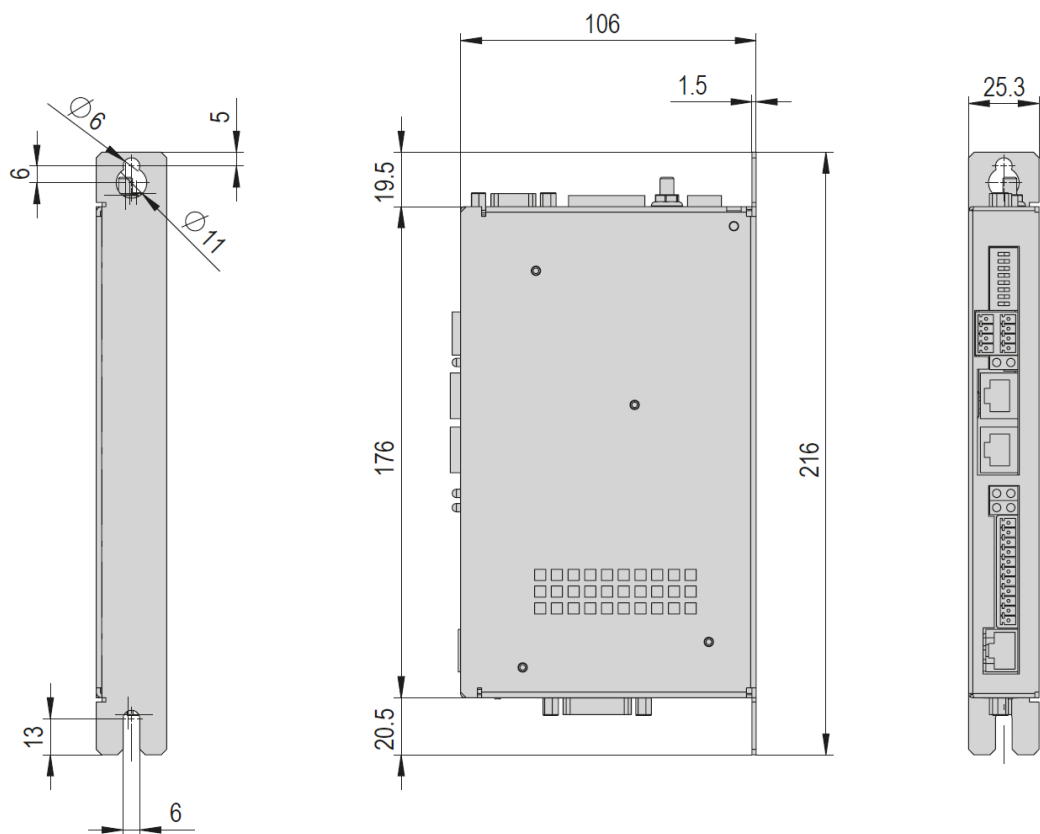

#### Included in the delivery

- 1x Plug kit for C1xxx-1S

#### Accessories

- Power supply S01-72/500, 1-phase
- Motor plug for controller C1x00
- USB-RS232 Converter for controllers

#### Alternative Accessories

- Additional power supplies

**Controller E12xx**

E12xx	
Operating temperature	0 - 40 °C
Bearing temperature	-25 - 40 °C
Humidity	< 90 %

Type	E1250 Powerlink PL-UC	E1250 Ethernet IP-UC	E1250 Ethercat SoE SE-UC	E1250 Sercos III SC-UC
<b>Order number</b>	<b>50465787</b>	<b>50465792</b>	<b>50465793</b>	<b>50465794</b>
Net weight	1 kg	1 kg	1 kg	1 kg
Dimensions W x H x D	40x270x180 mm	40x270x180 mm	40x270x180 mm	40x270x180 mm
Nominal output current	32 A	32 A	32 A	32 A
Supply voltage	24 - 72 VDC	24 - 72 VDC	24 - 72 VDC	24 - 72 VDC
Control voltage	24 VDC	24 VDC	24 VDC	24 VDC
Protection type	IP 20	IP 20	IP 20	IP 20
Intermediate circuit voltage	max. 91 VDC	max. 91 VDC	max. 91 VDC	max. 91 VDC
Programming interface	RS 232 + Ethernet	RS 232 + Ethernet	RS 232 + Ethernet	RS 232 + Ethernet

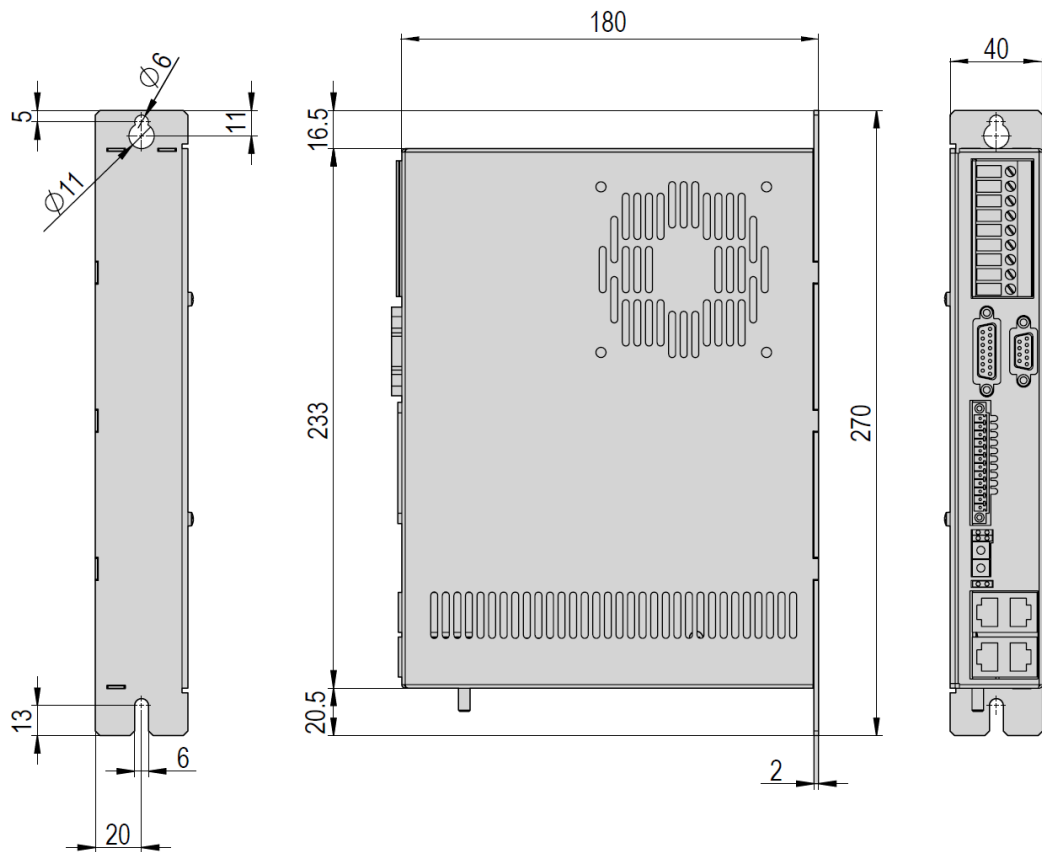
**Accessories**

- Power supply S01-72/500, 1-phase
- USB-RS232 Converter for controllers

**Alternative Accessories**

- Additional power supplies



## Structure and description

### 5.3.3 Controllers, cables, plugs





**C11xx & C12xx**

■

	M		G	R	Motor connector	Plug X3	Adapter
	...-X	...-1	...-2	...-1			
ES12	M16	M16	M16				50455642
ES20	M16	M16	M16				
ES30	M23	M17					
ES40	M23	M17					
SA-1		M10		G14	R8	50426481	50530603
SA-3		M10		G14	R1	50426481	50530603
SA-6		M18		G16	R1	50426481	50530603
PEZ-52		M18		G16	R1	50426481	50530603
PEZ-65		M18		G16	R1	50426481	50530603
PDZ-128		M18		G16	R1	50426481	50530603
PEL20	M16	M16	M16				
PDL30	M23	M17					
PDL40	M23	M17					
RE-50 18-100V		M12		G14	R1	50426481	
RE-75 18-100V A		M27		G14	R1	50426481	
RA-40	M16	M16	M16				
SE20	M16	M16	M16				
SE30	M23	M17					
SG-50-Abq		M19				50426481	



The C11xx and C12xx controllers are supplied with a plug set.

←

→

**USB-RS232 converter for Linmot controller**



**E12xx**

	M			G	R	Adapter
	...X	...-1	...-2	...-1	...-1	
ES12	M20	M20				50455642
ES20	M20	M20				
ES30	M24	M22	M22			
ES40	M24	M22	M22			
SA-1		M10		G14	R8	
SA-3		M10		G14	R1	
SA-6		M18		G16	R1	
PEZ-52		M18		G16	R1	
PEZ-65		M18		G16	R1	
PDZ-128		M18		G16	R1	
PEL20	M20	M20				
PDL30	M24	M22	M22			
PDL40	M24	M22	M22			
RE-50 18-100V		M12		G14	R1	
RE-75 18-100V A		M27		G14	R1	
RA-40	M20	M20				
SE20	M20	M20				
SE30	M24	M22	M22			

## Accessories C1xxx

<b>Motor plug for controller C1xxx</b>	
<b>Order number</b>	<b>50426481</b>
Net weight	0.01 kg
<b>Plug kit for controller C1xxx-15</b>	
<b>Order number</b>	<b>50426471</b>
Net weight	0.02 kg
<b>USB-RS232 Converter for controllers</b>	
<b>Order number</b>	<b>50426494</b>
Net weight	0.07 kg
<b>Plug X3 for controller C1xxx</b>	
<b>Order number</b>	<b>50530603</b>
Net weight	0.02 kg

## Structure and description

### 5.3.4 Cable types

#### Motor cable M16-0-1-X

Motor cable-M16-0-1-X	4m-0-1-X	6m-0-1-X	8m-0-1-X
<b>Order number</b>	<b>50463073</b>	<b>50463076</b>	<b>50463078</b>
Net weight	0.6 kg	0.9 kg	1.2 kg
Cable Ø	8.2 mm	8.2 mm	8.2 mm
Min. bending radii	static 25 mm	static 25 mm	static 25 mm
Material	PUR	PUR	PUR
A	4 m	6 m	8 m

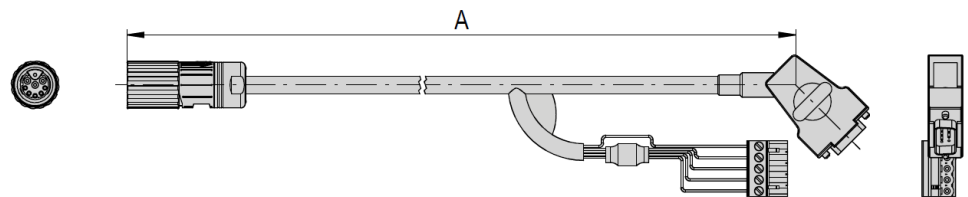

#### Motor cable M16-0-1-1

Motor cable M16-0-1-1	4m-0-1-1	6m-0-1-1	8m-0-1-1
<b>Order number</b>	<b>50437168</b>	<b>50437167</b>	<b>50427023</b>
Net weight	0.6 kg	0.9 kg	1.2 kg
Cable Ø	9.5 mm	9.5 mm	9.5 mm
Min. bending radii	60 mm	60 mm	60 mm
Material	PUR	PUR	PUR
A	4 m	6 m	8 m

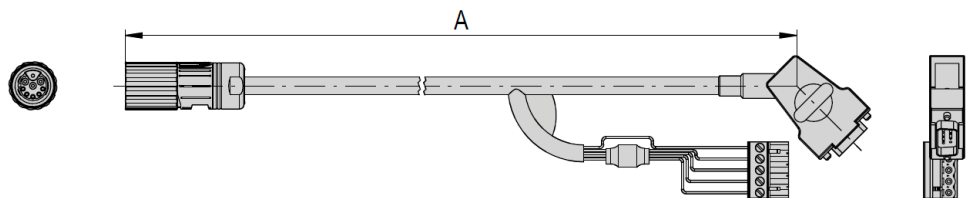

#### Motor cable extension to M16-0-0-1/2

Motor cable extension for M16-0-0-1/2	2m-0-0-1	4m-0-0-1	6m-0-0-1	2m-0-0-2
<b>Order number</b>	<b>50450944</b>	<b>50427026</b>	<b>50463082</b>	<b>50463081</b>
Net weight	0.3 kg	0.6 kg	0.9 kg	0.2 kg
Cable Ø	9.5 mm	9.5 mm	9.5 mm	9.7 mm
Min. bending radii	60 mm	60 mm	60 mm	60 mm
Material	PUR	PUR	PUR	PUR
A	2 m	4 m	6 m	2 m

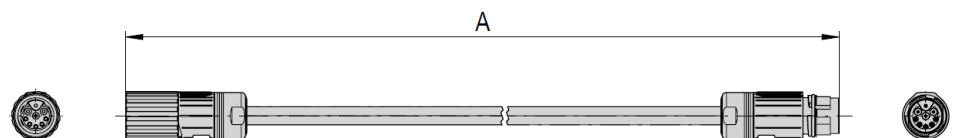

**Motor cable-M20-0-2-X**

Motor cable-M20-0-2-X	4m-0-2-X	6m-0-2-X	8m-0-2-X
<b>Order number</b>	<b>50463088</b>	<b>50463090</b>	<b>50463092</b>
Net weight	0.6 kg	0.9 kg	1.2 kg
Cable Ø	8.2 mm	8.2 mm	8.2 mm
Min. bending radii	static 25 mm	static 25 mm	static 25 mm
Material	PUR	PUR	PUR
A	4 m	6 m	8 m

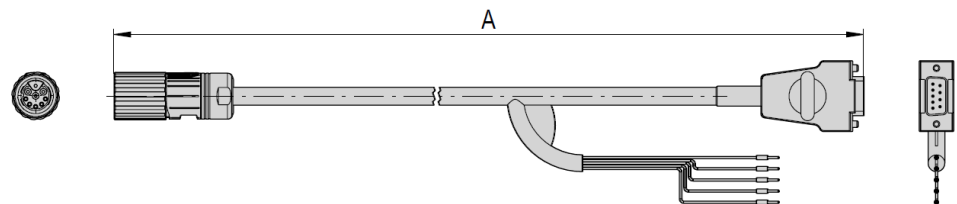
**Motor cable-M20-0-2-1**

Motor cable-M20-0-2-1	4m-0-2-1	6m-0-2-1	8m-0-2-1
<b>Order number</b>	<b>50463089</b>	<b>50463091</b>	<b>50463093</b>
Net weight	0.6 kg	1 kg	1.3 kg
Cable Ø	9.5 mm	9.5 mm	9.5 mm
Min. bending radii	60 mm	60 mm	60 mm
Material	PUR	PUR	PUR
A	4 m	6 m	8 m

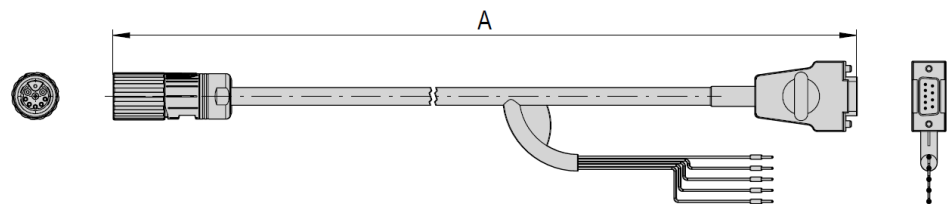
**Adapter ES8/12 Cable M16**

Adapter ES8/12 cable M16	
<b>Order number</b>	<b>50455642</b>
Net weight	0.1 kg
Cable Ø	11.2 mm
Min. bending radii	static 50
Material	PUR
A	0.11 m

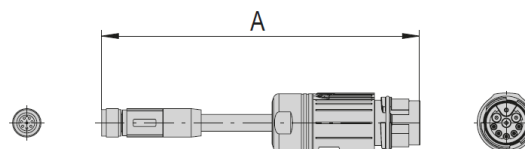

## 6 Installation, assembly and setting

---



The customer is responsible for the installation of the electric slides into the automation system!

---

### 6.1 Safety Instructions for installation and assembly

The electric slide is an incomplete machine.

For safe operation, the electric slides must be integrated into the safety concept of the automation system in which they are installed.

During normal operation it must be ensured that the user cannot interfere with the working area of the electric slide.



When installing an electric slide in an assembly system, the system operator must provide the system with a protective device with a locked door safety circuit!

---

#### CAUTION



#### Danger of injury from attachments!

The electric slide is electrically controlled. Attachments can restrict the free movement of the electric slide and cause injuries such as crushing.

- Make sure that the movement of the is not restricted by mounted attachments.
  - Take appropriate measures to ensure safe operation!
- 



No liability can be assumed for damages caused by improper installation/assembling work carried out by the operator.

---



Also observe the safety instructions in  chapter 2 „Safety instructions“ in this manual.

---

## 6.2 Assembly and attachment

We generally recommend mounting the ES8 and ES12 in horizontal position, since no load compensation is provided for vertical installation.



The electric slides may only be installed in vertical position upon consultation with AFAG Automation AG. For vertical installation a counterbalance by means of a spring is required (not included in the standard version).

### 6.2.1 Mounting holes

The mounting holes (M3 for ES8) and (M4 for ES12) are located on the base element. The mounting holes M2.5 and M3 (for ES8) and M4 (for ES12) are located on the slide.

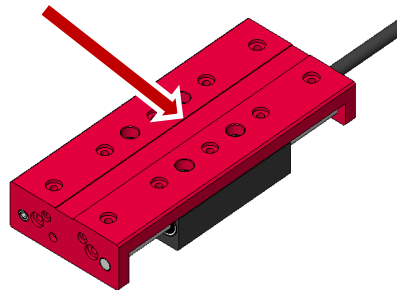

Module		
ES12	M4	Hole pitch 30x30 mm

Fig. 6 Mounting holes on the slide

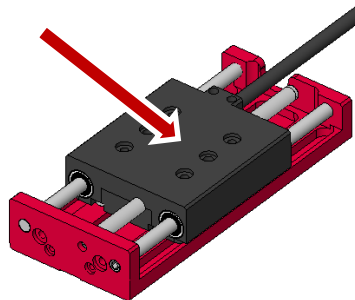

Module		
ES12	M4	Hole pitch 30x30 mm

Fig. 7 Mounting holes on the base element



For mounting use the centering sleeves (➡ chapter 6.2.2) included in the scope of delivery.

## 6.2.2 Centering bushing

Use the centring sleeves supplied for positioning. Insert the centering sleeves in two diagonally opposed holes of the installation grid.

ES12	Base element	Slide
Hole grid	30 x 30 mm	30 x 30 mm
Bore hole and fastening thread	M4	M4
Centr. sleeves (H7) 11016850	Ø 7 mm	Ø 7 mm

Centering bushings	Ø4x2	Ø5x2.5	Ø7x3	Ø8x3.5	Ø9x4	Ø12x4.8	Ø19x5.8
Order number	50332257	50035831	11016850	50263565	11004942	50187424	50189497
Net weight	0.001 kg	0.001 kg	0.001 kg	0.001 kg	0.001 kg	0.002 kg	0.006 kg
A	4 mm	5 mm	7 mm	8 mm	9 mm	12 mm	19 mm
B	2 mm	2.5 mm	3 mm	3.5 mm	4 mm	4.8 mm	5.8 mm
C	2.6 mm	3.2 mm	4.3 mm	5.4 mm	6.5 mm	8.5 mm	13 mm

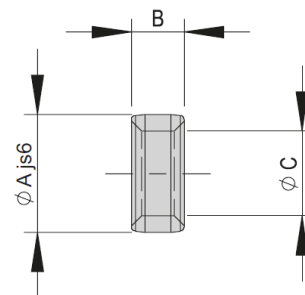

Attachment grid	16x16 mm	20x20 mm	30x30 mm	38x38 mm	48x48 mm	60x60 mm	75x75 mm	96x96 mm
A	16 mm	20 mm	30 mm	38 mm	48 mm	60 mm	75 mm	96 mm
B	8 mm	10 mm	15 mm	19 mm	24 mm	30 mm	38 mm	48 mm
C	4x1.1 mm	5x1.3 mm	7x1.6 mm	8x1.8 mm	9x2.1 mm	12x2.5 mm	15x2.7 mm	19x3 mm
D	M2.5	M3	M4	M5	M6	M8	M10	M12

### Module-centering, centering bushings

In order to guarantee a high and repetitive fit accuracy during installation, operation or replacement of a module, all components of the entire program are consequently provided with a precise module centering. Centering bushings or pins are supplied as standard with each module.

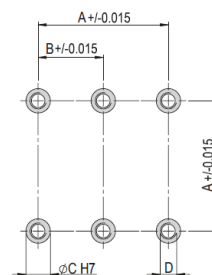

### 6.2.3 Tightening torques

For assembling use screws with the following minimum specifications:

Standard	VDI 2230
Screw strength	Category 8.8
Surface:	Galvanized blue, oiled or greased

Thread	Tightening torque
M3	1.1 ... 1.4 Nm
M4	2.6 ... 3.3 Nm
M5	5.2 ... 6.5 Nm
M6	9.0 ... 11.3 Nm
M8	21.6 ... 27.3 Nm

### 6.2.4 Mounting (slide)

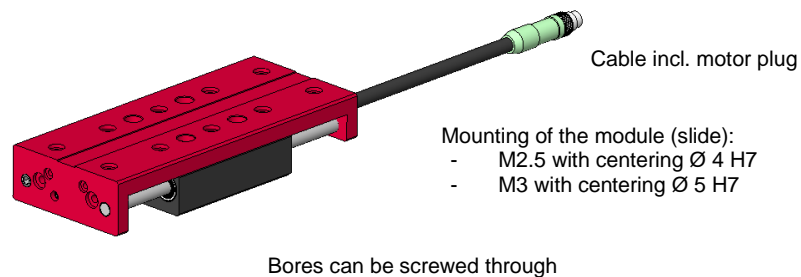

- Mounting of the module (slide):
- M2.5 with centering  $\varnothing$  4 H7
  - M3 with centering  $\varnothing$  5 H7

Bores can be screwed through

Fastening of the periphery:  
2x M3 with centring  $\varnothing$  5 H7 hole pitch 20 mm

Fig. 8 Electric slide ES (mounting of the slide)

### 6.2.5 Mounting (basic element)

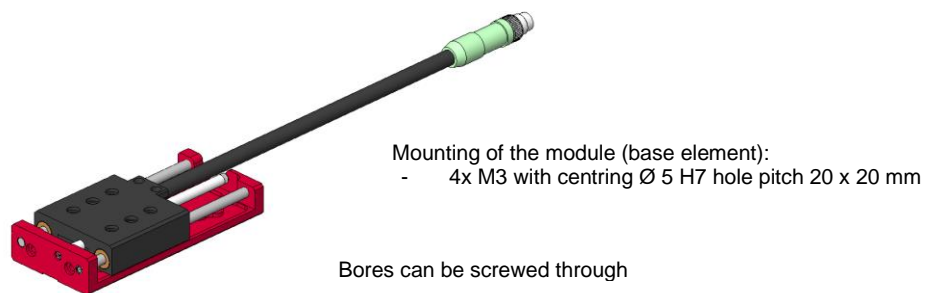

Fig. 9 Electric slide ES (mounting basic element)



### 6.3 Programming of the electric slides

#### 6.3.1 Safety instructions for programming



#### WARNING

---

##### **Risk of injury due to flying parts ejected from the module!**

If the control unit is incorrectly programmed, the electric slides can move to the stop position unbraked and injure persons by ejected parts.

- Programming should only be carried out by qualified personnel.
  - Observe the operating instructions of the control system used!
- 



#### CAUTION

---

##### **Risk of injuries due to uncontrolled parts movements!**

If the position sensor fails or a limit switch cable is defective, unexpected movements of the electric slides may occur and cause injuries.

- Replace the defective position sensor or limit switch cable immediately.
- 

#### 6.3.2 Programming



---

The programming differs depending on the control system used.

Observe the respective manuals of the control system manufacturer!

---

## 7 Commissioning

After connection, the electric slides are put into operation for the first time via the control.

### 7.1 Safety instructions for commissioning

#### WARNING



##### **Risk of injury from incorrect programming!**

Incorrect programming can cause uncontrolled movements of the ES, resulting in serious injury or death and material damage.

- Commissioning must only be carried out in setup mode or jog mode.
  - Before working on the electric slide, make sure that the control unit is switched off and that it cannot be switched on again unintentionally.
- 

#### CAUTION



##### **Danger of injury in the working area of the electric slides!**

Due to the decentralised control system, the operator of the electric slide must not necessarily stand next to the rotary modules during operation so that he may not have a complete view of the working area. Persons within the working area may be injured.

- When operating the electric slides, ensure a good overview of the entire working area.
  - Unauthorized persons must not stay within the working area during operation.
- 

#### CAUTION



##### **Risk of injuries due to uncontrolled parts movements!**

When the control unit is switched on, signals from the control unit can lead to unintentional movements of the electric slides and cause serious injuries or material damage.

- When working on the electric slides, make sure that the control unit is switched off and that it cannot be switched on again unintentionally.
  - Only connect or disconnect the cables when the control unit is switched off.
  - Observe the operating instructions of the controller used!
- 



Observe the safety instructions in  chapter 2 "Safety instructions" of these mounting instructions!

---

### 7.2 Preparatory activities for commissioning

The electric slide is designed for operation with LinMot servo controllers.

The operation of the servo controllers is described in the operating manual of the respective servo controller.

To prepare commissioning proceed as follows:

1. Connect the electric slide with the motor cable M16 and an adapter cable to the servo controller.
2. For test operation:
  - Connect the servo controller to a computer on which the operating software is installed (refer to ↻ operating instructions of the operating software)



If the electric slide is delivered with a LinMot servo controller, the operating parameters are already stored in the controller.

The electric slide can be operated immediately.

#### CAUTION

##### **Danger due to missing safety devices!**

Operating the electric slide without appropriate protective devices can lead to considerable material damage and injuries.



- The user must provide protective hoods, safety doors or other appropriate safety measures for operation!
- These safety devices must comply with the usual safety guidelines and safety standards and prevent people from being in the working area of the electric slide in an appropriate manner.
- The electric slides may only be put into operation with closed and functioning safety devices!

### 7.3 Commissioning of the modules

Proceed carefully and follow the instructions step by step when commissioning the modules for the first time:

1. Observe the permissible technical values (↻ Chapter 3).
  - Payload
  - Movement frequency
  - Momentary load
2. Make sure that there are no persons or tools in the working area.
3. Connect the cable to the electric slide and the system control.
4. Perform test run:
  - Start with slow movements
  - Then continue under normal operating conditions

⇒ Commissioning is completed.

### Setting the speeds on the electric axes

The speeds of the electric axes are usually specified by the higher-level control system.

A variety of example programs are available for a large number of common control systems. This allows the target speed, the acceleration and the target position to be specified.

#### NOTICE

##### **Material damage due to excessive speeds or acceleration!**

Excessively high speeds or acceleration can cause damage to the electric slide or the periphery.

- Observe the operating instructions of the control unit used!
- 

## 7.4 Setting up & retrofitting



---

Before carrying out any setting work at the electric slide, deactivate the controller enable. Activate the controller enable only after the work has been completed!

---

#### CAUTION



##### **Risk of injury due to incorrect operation of the system!**

Incorrect operation during setup work on the machine can lead to unintentional starting of the electric slide and cause injuries.

- Setting up and retrofitting work may only be carried out by qualified personnel.
  - Observe the operating instructions!
- 

#### CAUTION



##### **Danger of injury from attachments!**

The electric slide is electrically controlled. Attachments can restrict the free movement of the electric slide and lead to injuries.

- Ensure that the movement of the electric slide is not restricted by mounted attachments.
  - Take appropriate measures to ensure safe operation!
-

## 8 Fault elimination

### 8.1 Safety instructions for troubleshooting

#### WARNING



#### Danger of injury due to faulty troubleshooting!

Poorly performed troubleshooting work can lead to serious injuries and damage to property.

- Only use trained specialist personnel for troubleshooting.
- All work on the electric slides must be carried out with the power supply cut off!

#### NOTICE

#### Risk of material damage due to unexpected movements!

There is a risk of material damage if unusual movement of the electric slides (e.g. hard shocks) is detected during normal operation.

- Stop the system immediately and eliminate the cause!



Also observe the safety instructions in  chapter 2 „Safety instructions“ in this manual.

### 8.2 Fault causes and remedy

The following table contains an overview of possible fault causes and how to proceed to eliminate them.

Fault	Possible cause	Remedy:
Slide does not move	<ul style="list-style-type: none"> <li>▪ Payload too high</li> <li>▪ Slide blocked by foreign matter</li> <li>▪ Module defect</li> <li>▪ Module incorrectly connected</li> </ul>	<ul style="list-style-type: none"> <li>▪ Reduce payload</li> <li>▪ Remove foreign matter</li> <li>▪ Send module to Afag for overhaul</li> <li>▪ Check connections and connect module correctly</li> </ul>
Slide does not approach end position correctly	<ul style="list-style-type: none"> <li>▪ Incorrect control</li> </ul>	<ul style="list-style-type: none"> <li>▪ Check and correct control</li> </ul>
Abnormal noises or rough running	<ul style="list-style-type: none"> <li>▪ Soiling of the module</li> <li>▪ Tensions</li> <li>▪ insufficient lubrication</li> </ul>	<ul style="list-style-type: none"> <li>▪ Cleaning the module</li> <li>▪ Install the module without tension</li> <li>▪ Lubricating the module</li> </ul>

## 9 Maintenance and repair

### 9.1 General notes

The electric slides are almost maintenance-free. Nevertheless, some maintenance work must be carried out to ensure an optimum operating condition of the electric slides.

### 9.2 Safety instructions for maintenance and repair

#### WARNING



##### **Danger of injury due to improper maintenance!**

Improperly carried out maintenance activities can cause considerable damage to property and serious injury.

- Only use qualified personnel to carry out the activities.
  - Always wear personal protective equipment when carrying out maintenance and repair work!
- 

#### WARNING



##### **Risk of injuries due to uncontrolled parts movements!**

Signals from the control system can trigger unintentional movements of the electric slides and cause injury.

- Before starting any work on the electric slides, switch off the control unit and make sure that it cannot be switched on again unintentionally. Observe the operating instructions of the controller used!
  - Before starting any activities, switch off the media supply and make sure it cannot be switched on again unintentionally!
- 



Also observe the safety instructions in  chapter 2 „Safety instructions“ in this manual.

---

### 9.3 Maintenance activities and maintenance intervals





- Observe the specified maintenance and care intervals. The intervals refer to normal operating conditions.
- If the electric slides are to be operated in an environment with abrasive dusts or corrosive or aggressive vapours, gases or liquids, the approval of Afag Automation AG must be obtained in advance.

#### 9.3.1 Overview of the maintenance points



Fig. 10 Electric slide

No.	Maintenance point	Maintenance work	Interval	System [On/Off]	Remarks
1	Fasteners	Checking 	After commissioning	[Off]	-
			<ul style="list-style-type: none"> <li>▪ Check screws for tight fit</li> </ul>		
2	Guideways	Cleaning 	After commissioning	[Off]	-
			- Clean guides with a slightly oily cloth		
3	Guideways	Lubricating 	every 3 months	[Off]	Type of grease: Klübersynth UH1 14-31
			<ul style="list-style-type: none"> <li>▪ Lubricate the guides. Linear motor axes may only be lubricated with the specified grease!</li> </ul>		

#### 9.3.2 Further maintenance

Further maintenance is not required, if the ambient conditions listed below are complied with:

- Clean working area
- No use of splash water
- No abrasive or process dust and vapours
- Ambient conditions as specified in the technical data

#### 9.4 Spare parts and repair work

AFAG Automation AG offers a reliable repair service. Defective electric slides can be sent to AFAG for repair within the warranty period.

After expiry of the warranty period, the customer may replace or repair defective modules or wear parts himself or send them to the AFAG repair service.



Please note that AFAG does not provide any warranty for modules that have not been replaced or repaired by AFAG!

---

#### CAUTION

##### **Risk of injury when removing the electric slides from uncontrolled movements!**

When dismantling the electric slides from the machine, there is a danger of uncontrolled movements.

- Disconnect the media supply (electrics) before removing the grippers!
  - Disassembling should only be carried out by qualified personnel!
  - Only remove the electric slides when the control system is switched off and secured!
- 





### 10 Decommissioning and disposal

The electric slides must be properly dismantled after use and disposed of in an environmentally friendly manner.

#### 10.1 Safety instructions for decommissioning and disposal

##### WARNING



##### **Risk of injury from improper decommissioning and disposal!**

Improperly carried out activities can result in considerable material damage and serious injury.

- Use only qualified personnel to carry out the activities.
  - Disconnect the media supply (electrics) before removing the grippers!
  - Only remove the electric slides when the control system is switched off and secured!
- 

#### 10.2 Decommissioning

If the electric slides are not used for a longer period of time, they must be properly decommissioned and stored as described in  chapter 4.5.

#### 10.3 Disposal

The electric slides must be disposed of properly at the end of their service life and the raw materials used must be recycled. Observe the legal regulations and company requirements.

The electric slides must not be disposed of as a complete unit. Dismantle the electric slides and separate the various components according to type of material and dispose of properly:

- Scrap the metallic materials.
- Hand over plastic parts for recycling.
- Sort the rest of the components by their material properties and dispose of them accordingly.

##### NOTICE

##### **Risk to the environment from incorrect disposal of the electric slides.**

Environmental damage can be caused by improper disposal of the electric slides.

- Electronic parts, electrical scrap, auxiliary and operating materials must be disposed of by approved specialist companies.
  - Information on proper disposal can be obtained from the responsible local authorities.
-

## 11 Declaration of incorporation

### Declaration of incorporation

for partly completed machinery according to the Machinery Directive 2006/42/EC, Annex II, 1.B

The manufacturer hereby declares:

**Afag Automation AG, Luzernstrasse 32, CH-6144 Zell**

that the partly completed machine:

Product description	Electric slide ES
Type:	ES8-15, ES8-40, ES12-20, ES12-60, ES12-100

complies with the following essential health and safety requirements of the Machinery Directive 2006/42/EC at the time of declaration: 1.1; 1.1.1; 1.1.2; 1.1.3, 1.1.5, 1.3.2, 1.3.4 and 1.5.1

Harmonised standards applied, in particular:	
2014/30/EU	Electromagnetic Compatibility Directive (EMC)
2014/35/EU	Low Voltage Directive (LVD)
EN ISO 12100:2010	Safety of machinery - General design principles - Risk assessment and risk reduction.
DIN EN 60204-1:2018	Safety of machinery - Electrical equipment of machines - Part 1: General requirements

**Note:** The partly completed machinery must not be put into service until the machinery into which it is to be incorporated has been declared in conformity with the provisions of Machinery Directive 2006/42/EC.

The manufacturer undertakes to transmit, in response to a reasoned request by the national authorities, relevant technical documentation for the partly completed machinery.

The relevant technical documentation was created according to Annex VII, Part B of the above-mentioned Directive.

#### Authorised representative for compiling the technical documentation:

Niklaus Röthlisberger, Product Manager, Afag Automation AG, CH-6144 Zell

Zell, 31.05.2023

Adrian Fuchser



CEO Afag Gruppe

Klaus Bott



CTO Afag Gruppe

Afag Automation AG  
Luzernstrasse 32  
6144 Zell  
Switzerland  
T +41 62 959 86 86  
sales@afag.com

Afag GmbH  
Wernher-von-Braun-Straße 1  
92224 Amberg  
Germany  
T +49 9621 650 27-0  
sales@afag.com

Afag Engineering GmbH  
Gewerbestraße 11  
78739 Hardt  
Germany  
T +49 7422 560 03-0  
sales@afag.com

Afag Automation Americas  
Schaeff Machinery & Services LLC.  
883 Seven Oaks Blvd, Suite 800  
Smyrna, TN 37167  
USA  
T +1 615 730 7515  
nashville@afag.com

Afag Automation APAC  
Afag Automation Technology (Shanghai) Co., Ltd.  
Room 102, 1/F, Bldg. 56, City Of Elite  
No.1000, Jinhai Road, Pudong New District  
Shanghai, 201206  
China  
T +86 021 5895 8065  
shanghai@afag.com